

Tru Trac™

Small Block Chevrolet
Installation Manual
For Systems With A/C
#13220 / #13120

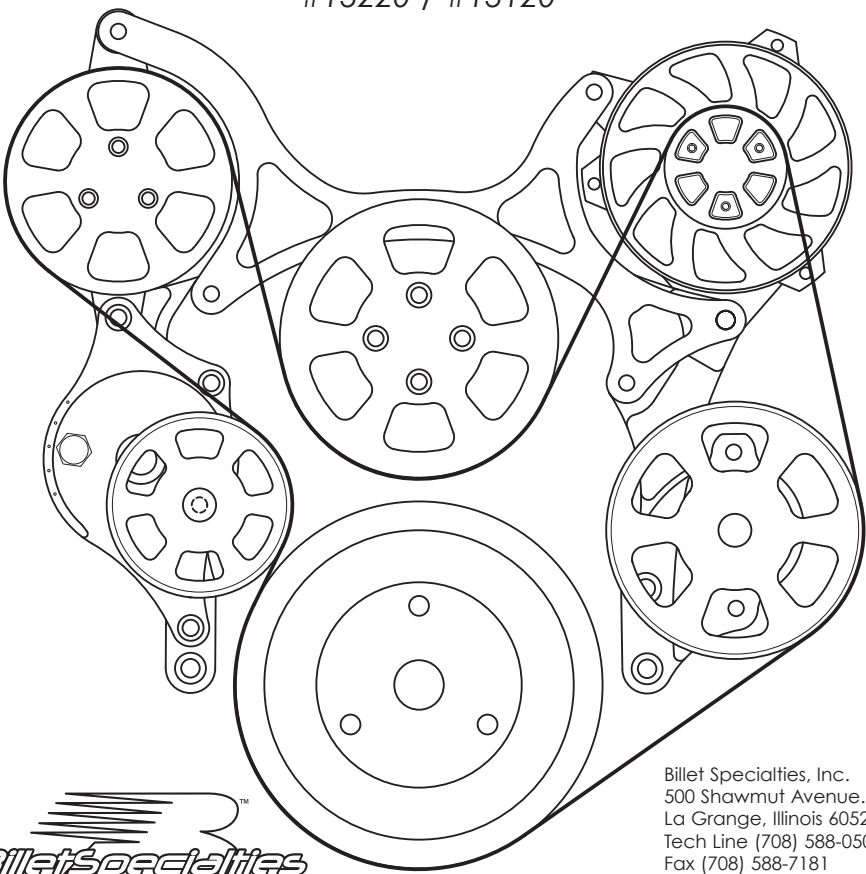

Billet Specialties, Inc.
500 Shawmut Avenue.
La Grange, Illinois 60526
Tech Line (708) 588-0505
Fax (708) 588-7181

PLEASE READ ALL INSTRUCTIONS BEFORE INSTALLING ANY COMPONENTS OF THE TRU TRAC SERPENTINE SYSTEM

Tech Line: 708.588.0505
 Fax: 708.588.7181
 www.billetspecialties.com

Required Tools & Materials

- | | | |
|---|--|--------------------------------------|
| <input type="checkbox"/> Anti-seize Compound | <input type="checkbox"/> 5/8" Combo Wrench | <input type="checkbox"/> 3/16" Allen |
| <input type="checkbox"/> RTV Silicone | <input type="checkbox"/> 9/16" Combo Wrench | <input type="checkbox"/> 5/16" Allen |
| <input type="checkbox"/> Loc-Tite® Thread Locker | <input type="checkbox"/> 11/16" Combo Wrench | <input type="checkbox"/> 1/4" Allen |
| <input type="checkbox"/> Gasket Scraper | <input type="checkbox"/> 3/4" Combo Wrench | <input type="checkbox"/> 6mm Allen |
| <input type="checkbox"/> Scotch-Brite® Pad | <input type="checkbox"/> Socket Wrench & Extension | |
| <input type="checkbox"/> 3/8-16 Thread Chaser* & Holder | <input type="checkbox"/> 10mm 12pt. socket | |
| <small>*Thread chasers are available at your local parts store and are different from a thread cutting tap.</small> | <input type="checkbox"/> 12mm 12pt. socket | |

TECH TIP:

Billet Specialties recommends the use of Anti-Seize on all fasteners to prevent thread lock-up.

Prepping the block:

- Disconnect the battery.
- Remove the existing alternator, air conditioning compressor and associated brackets.
- Remove all pulleys and water pump.
- Remove all traces of gasket and sealer with gasket scraper and Scotch Brite® pad.
- Clean threads in block by chasing with a 3/8-16 thread chaser.

Skin Board #1 - Packaged with Power Steering Pump

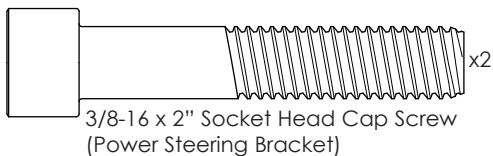
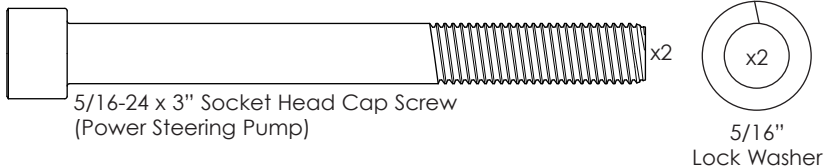

Skin Board #2 - Packaged with Water Pump

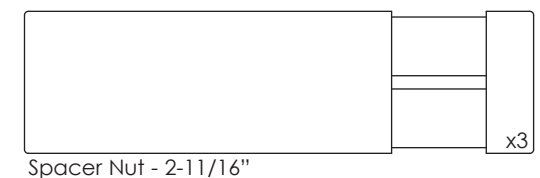
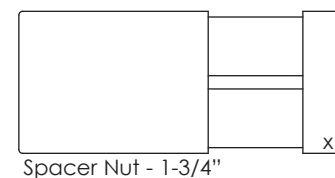
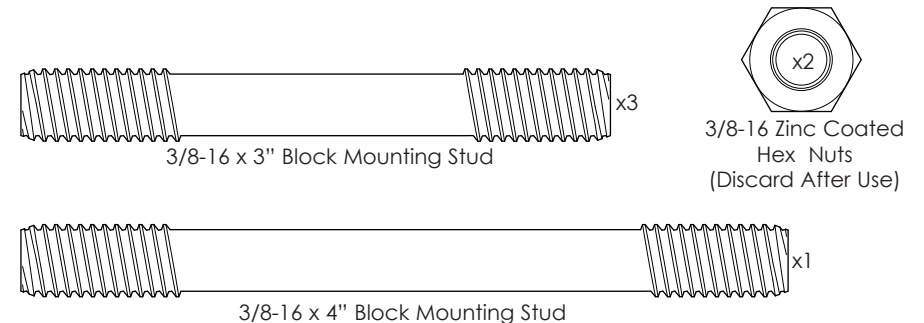

Skin Board #3 - Packaged In Main Box

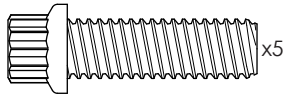

8mm-1.25 x 25mm 12pt. Cap Screw
(Bridge Bracket) x5

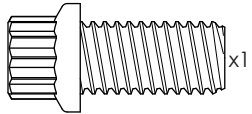

3/8-16 x 3/4" 12pt. Cap Screw
(Tensioner Pulley) x1

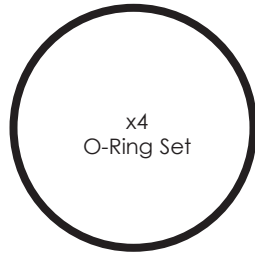

x4
O-Ring Set

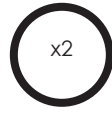

x2
O-Ring Set

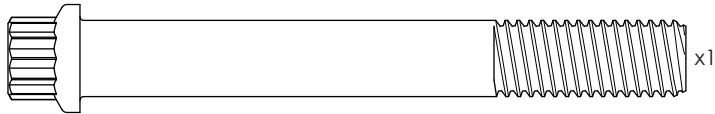

10mm-1.5 x 80mm 12pt. Cap Screw
(Alternator) x1

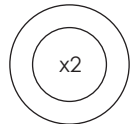

x2
10mm x .5mm
Shim Washer

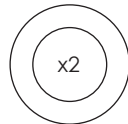

x2
10mm x 1mm
Shim Washer

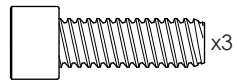

1/4-20 x 3/4"
Socket Head Cap Screw
(Compressor Cover) x3

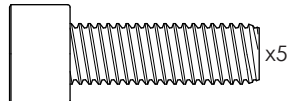

8mm-1.25 x 25mm Socket
Head Cap Screw
(Tensioner & A/C Manifold) x5

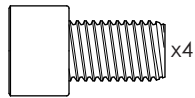

5/16-24x1/2"
Socket Head Cap Screw
(Water Pump Pulley) x4

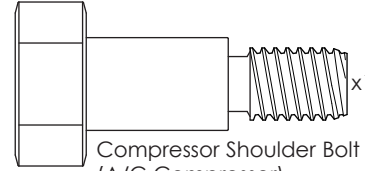

Compressor Shoulder Bolt
(A/C Compressor) x1

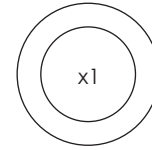

x1
Compressor Shoulder
Bolt Washer

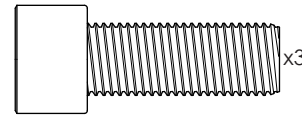

3/8-24 x 1" Socket Head Cap Screw
(Crankshaft Pulley) x3

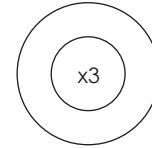

x3
3/8" Belleville Washer
(Crankshaft Pulley)

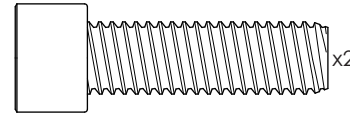

3/8-16 x 1-1/4" Socket Head Cap Screw
(Alternator Bracket) x2

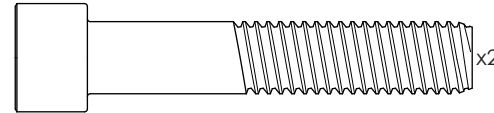

3/8-16 x 2" Socket Head Cap Screw
(Tensioner Bracket) x2

Other Hardware - Packaged With Power Steering Pump

Goodyear Poly-V Serpentine Belt - 63.5" #4060635 (with power steering)

Goodyear Poly-V Serpentine Belt - 61.0" #4060610 (without power steering)

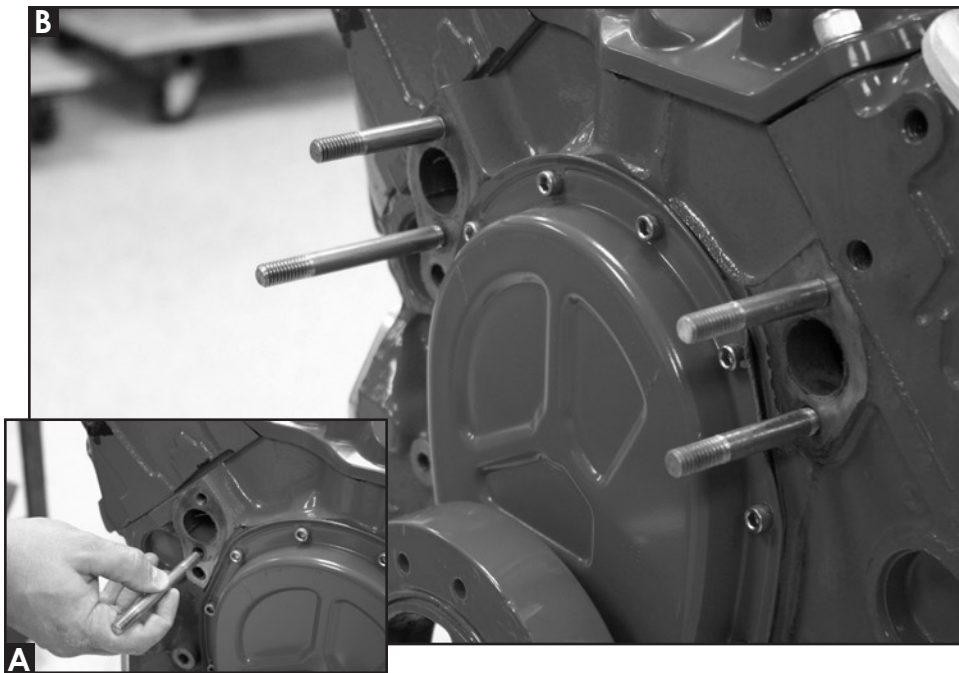

Figure 1: Install Mounting Studs

Apply RTV silicone to one end of each mounting stud.

A] Thread the 3/8-16 x 4" stud into the bottom passenger side.

B] Follow by threading the remaining three 3/8-16 x 3" studs into the three remaining water pump mounting holes.

Use the two included 3/8-16 zinc plated hex nuts tightened against each other to act as a drive nut to ease installation (see illustration below).

Example



Note for GM Crate Motors

The flat tab located on the passenger side of the plastic timing cover GM P/N 12562818 must be removed.

This tab interferes with installation of the compressor/tensioner bracket. Trim tab flush with timing cover.

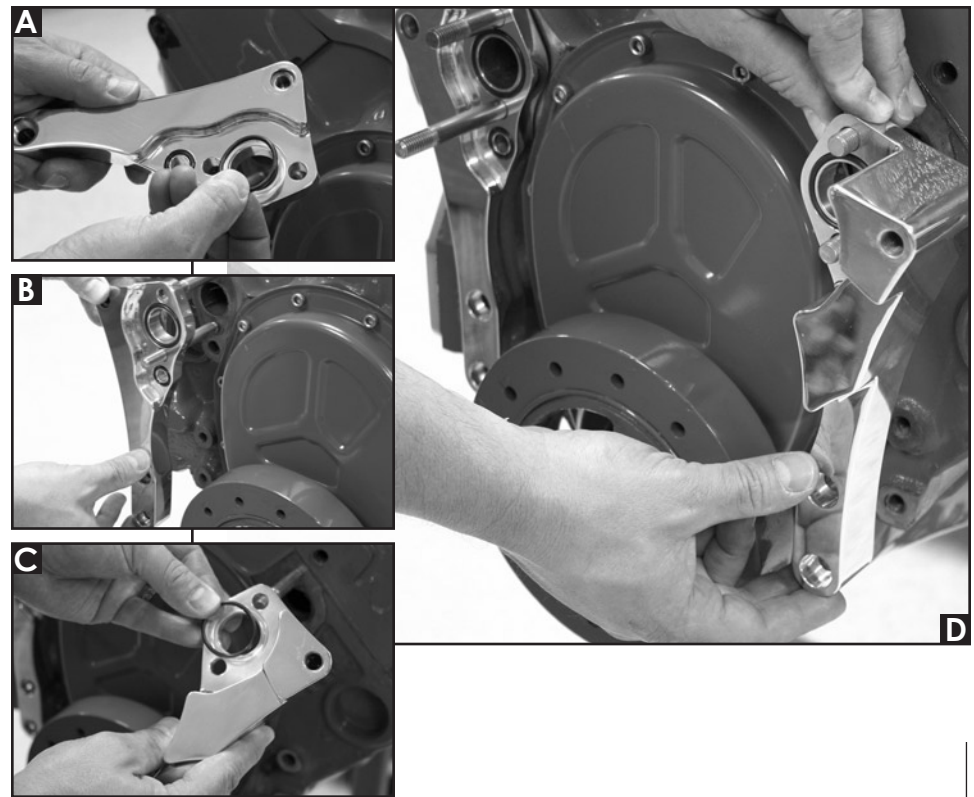
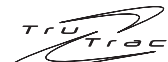
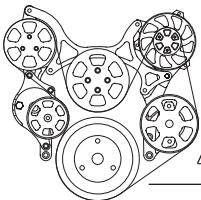
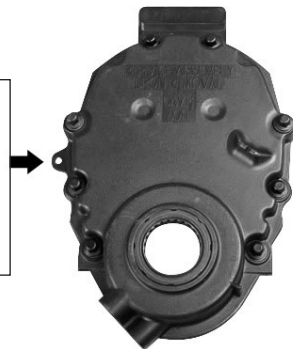

Figure 2: Install Compressor Bracket & Alternator Bracket

A] Locate the compressor bracket and install the large and small bypass o-rings to both sides of the bracket, make sure they are seated in the groove properly.

B] Finish by sliding the compressor bracket over the passenger side studs and seat against the block.

C] Locate the alternator bracket and install the two remaining o-rings 1 per side, make sure they are seated in the groove properly.

D] Finish by sliding the alternator bracket over the driver side studs and seat against block.

Apply anti-seize the exposed threads on each stud.



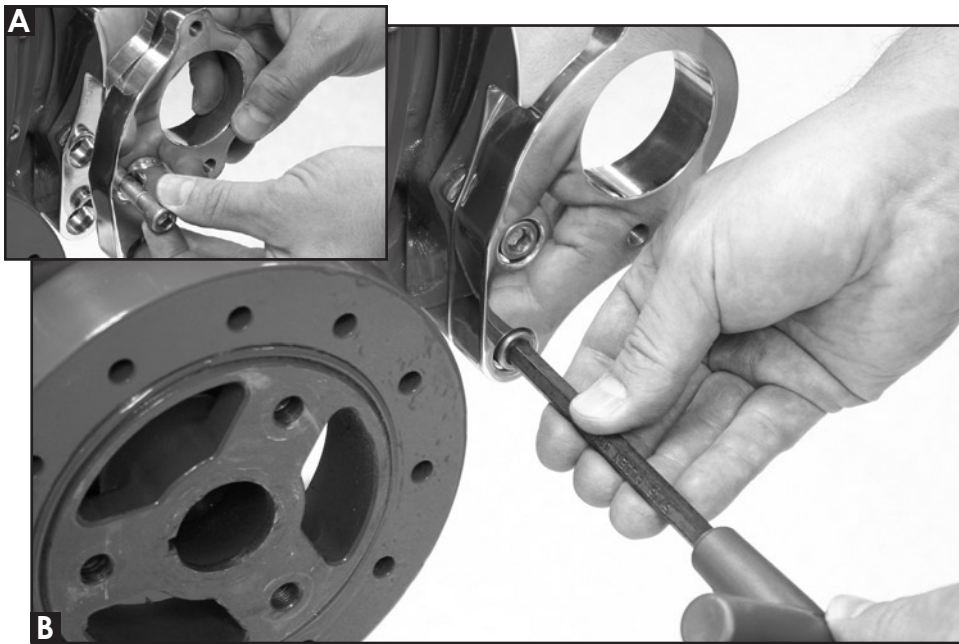

Figure 3: Install Power Steering Bracket

If your kit does not include power steering, now is the time to install the two 3/8-16 x 1-1/4" socket head cap screws through the alternator bracket and into the block, finger tighten.

If your kit does include power steering, locate the power steering bracket and place it onto the bottom of the alternator bracket.

A,B] Apply anti-seize to the threads of the two 3/8-16 x 2" socket head cap screws. Thread the two cap screws through the power steering bracket, alternator bracket and into the block, finger tighten.

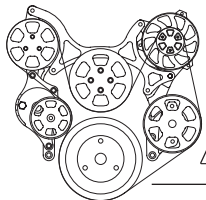

Figure 4: Install Tensioner Support Bracket

Apply anti-seize to the two 3/8-16 x 2" socket head cap screws.

Place tensioner support bracket onto compressor bracket.

Thread the two 3/8-16 x 2" socket head cap screws through support bracket, compressor bracket and into block, finger tighten.



Billet Specialties

TRU Trac



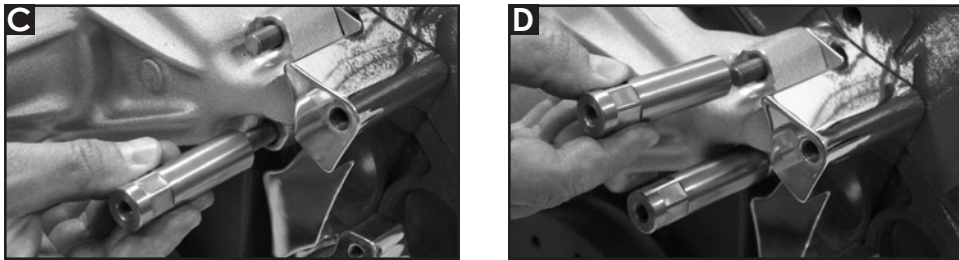
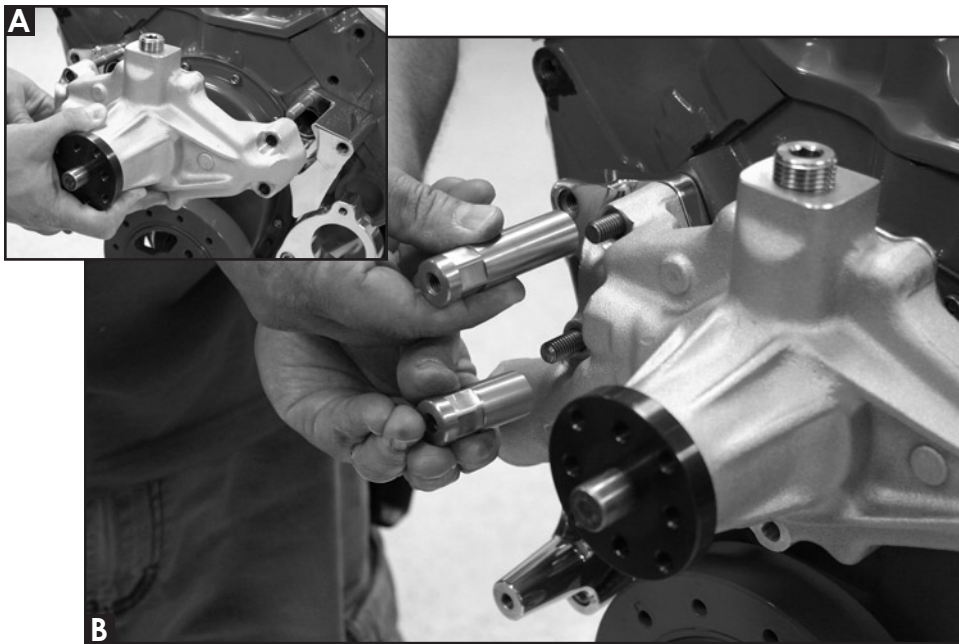

Figure 5: Install Water Pump & Spacer Nuts

A] Slide water pump over studs and seat against brackets.

B] Thread the short (1-3/4") spacer nut onto the bottom passenger stud with the hex end out and finger tighten.

B,C,D] Thread the three remaining long (2-11/16") spacer nuts with the hex end out onto the remaining studs.

Finish by firmly tightening each spacer nut to water pump, follow by firmly tightening the four 3/8" socket head cap screws at the bottom of each bracket.

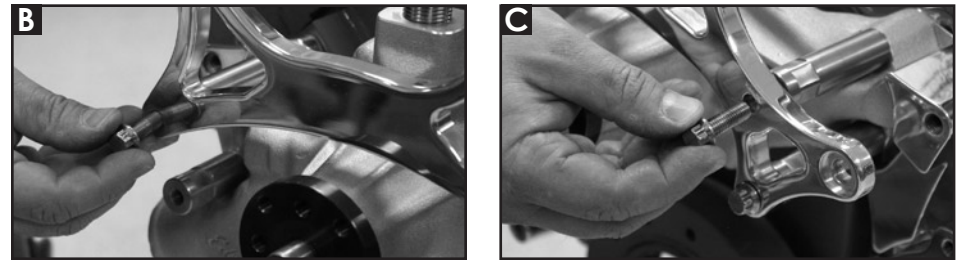

Figure 6: Install Bridge Bracket

Apply anti-seize to three 8mm-1.25 x 25mm ARP 12pt. cap screws.

Carefully place bridge bracket to spacer nuts, the side with three bolt holes is the driver side.

A] Thread the first 8mm-1.25 x 25mm 12pt. cap screw through bridge bracket and into driver side lower spacer nut, finger tighten.

B] Follow by threading second fastener through bridge bracket and into passenger side upper spacer nut, finger tighten.

C] Finish by threading remaining fastener through bridge bracket and into driver side upper spacer nut, finger tighten.

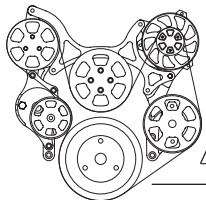

Billet Specialties

TRU Trac



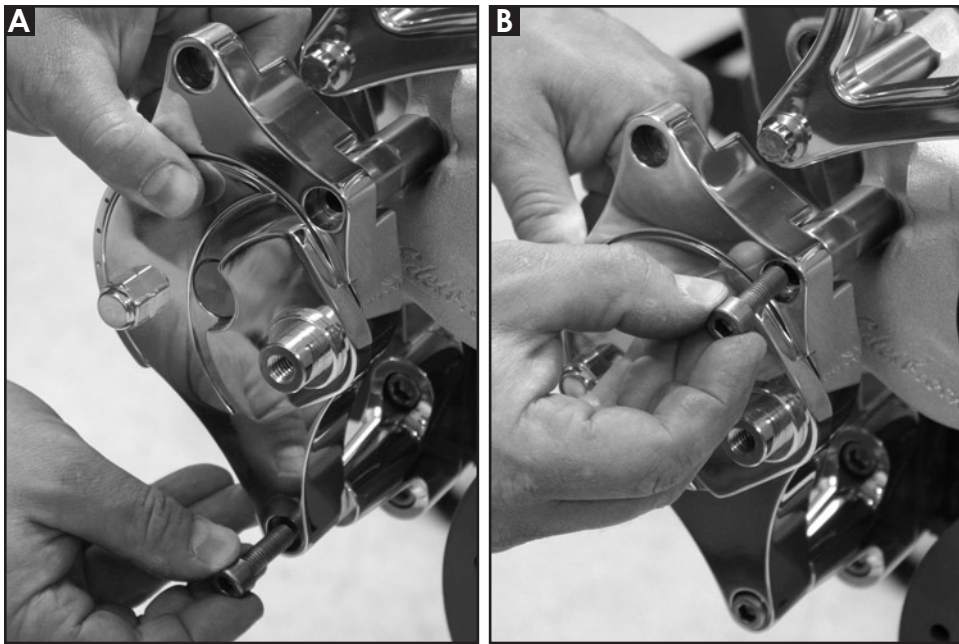

Figure 7: Install Tensioner

Apply anti-seize to two 8mm-1.25 x 25mm socket head cap screws.

Place tensioner as shown on remaining exposed spacer nut and tensioner support bracket.

A] Thread the first 8mm socket head cap screw through the bottom hole of the tensioner housing and into the tensioner support bracket.

B] Thread the remaining 8mm socket head cap screw through the middle hole on the tensioner housing and into the spacer nut.

Tighten both fasteners firmly at this time.

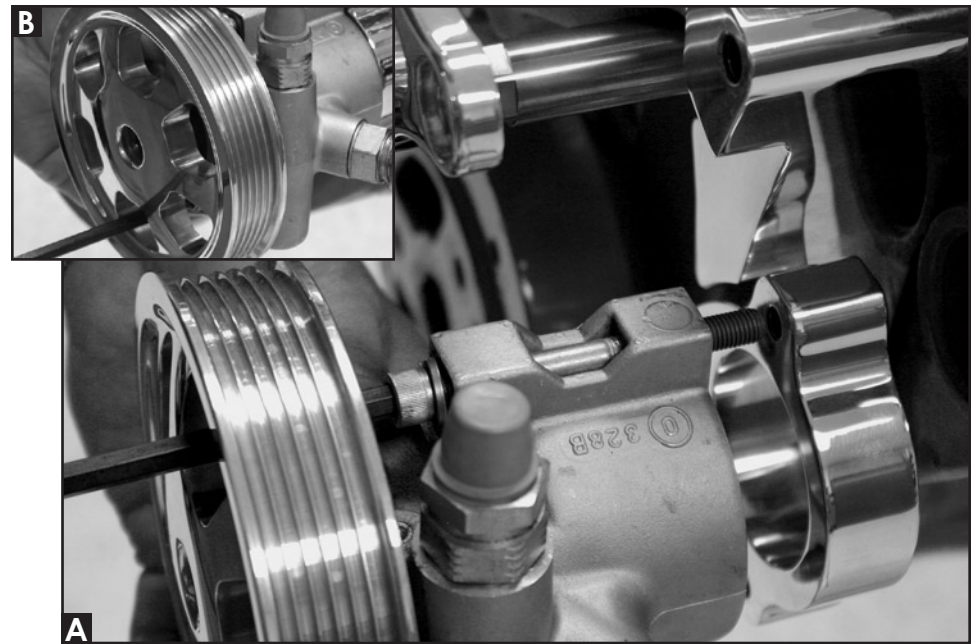

Figure 8: Install Power Steering Pump with Pulley

Apply anti-seize to the two 5/16-24 x 3" socket head cap screws.

Place power steering pump with pulley on power steering bracket and align holes.

A] Thread one 5/16-24 x 3" socket head cap screw with lock washer through the top holes on power steering pump and into bracket.

B] Thread the remaining 5/16-24 x 3" socket head cap screw with lock washer through the bottom holes on pump and into bracket.

Tighten both fasteners firmly at this time.



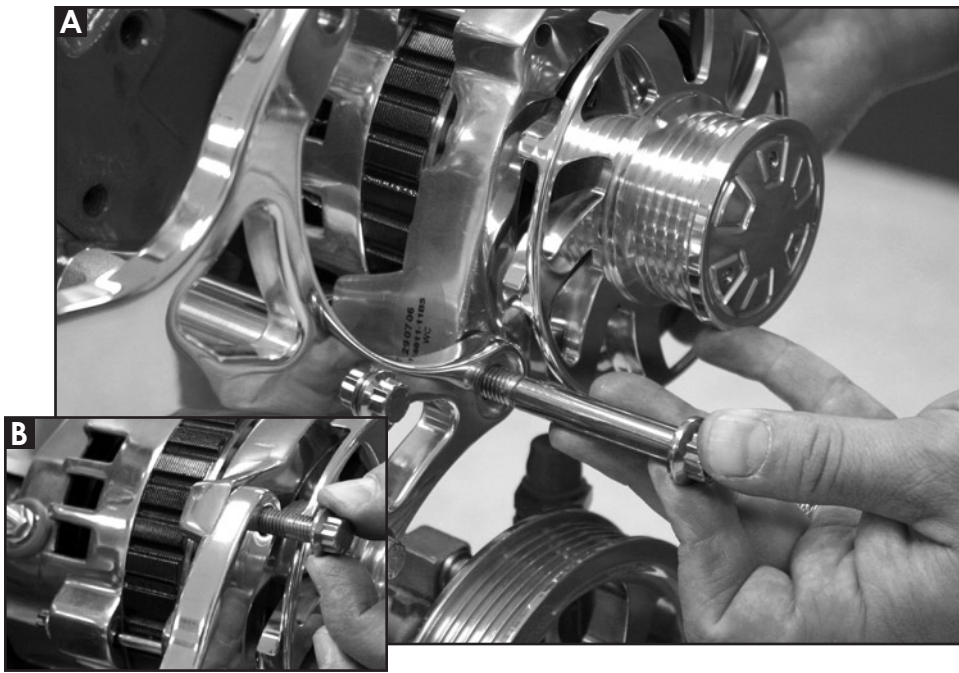

Figure 9: Install Alternator

Apply anti-seize to the 10mm-1.5 x 80mm ARP 12pt. cap screw and one 8mm-1.25 x 25mm ARP 12pt. cap screw.

Place alternator between the alternator bracket and bridge bracket, align the bottom holes.

A] Thread the 10mm ARP 12pt. fastener through bridge bracket, alternator and into alternator bracket, finger tighten.

Rotate alternator up to align the top alternator boss with the top bridge bracket ear.

B] Thread the 8mm ARP 12pt. cap screw through the bridge bracket and into alternator, finger tighten.

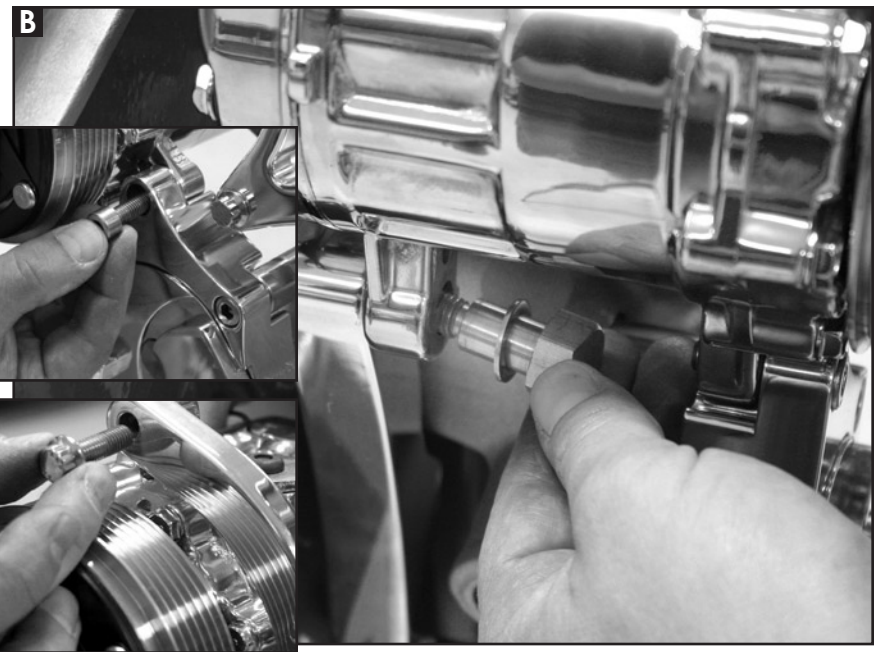

Figure 10: Install A/C Compressor

Apply anti-seize to the following:

- Compressor shoulder bolt
- 8mm-1.25 x 25mm socket head cap screw
- 8mm-1.25 x 25mm ARP 12pt. cap screw

Place compressor with the ports up between the bridge bracket and tensioner.

A] Thread the 8mm-1.25 x 25mm socket head cap screw through the top hole of the tensioner and into the compressor boss, finger tighten.

B] Thread the compressor shoulder bolt with washer through the back lower compressor boss and into the compressor bracket, finger tighten.

C] Swing the compressor up to align top compressor boss with upper bridge bracket ear, thread the 8mm ARP 12pt. cap screw through bridge bracket and into compressor. Tighten all compressor hardware firmly at this time.

Next tighten bridge bracket and upper alternator fastener firmly. The alternator boss may vary in width due to the polishing process. Check lower alternator mount boss to see if shims are needed, .5 & 1mm shim washers have been provided and may or may not be needed.



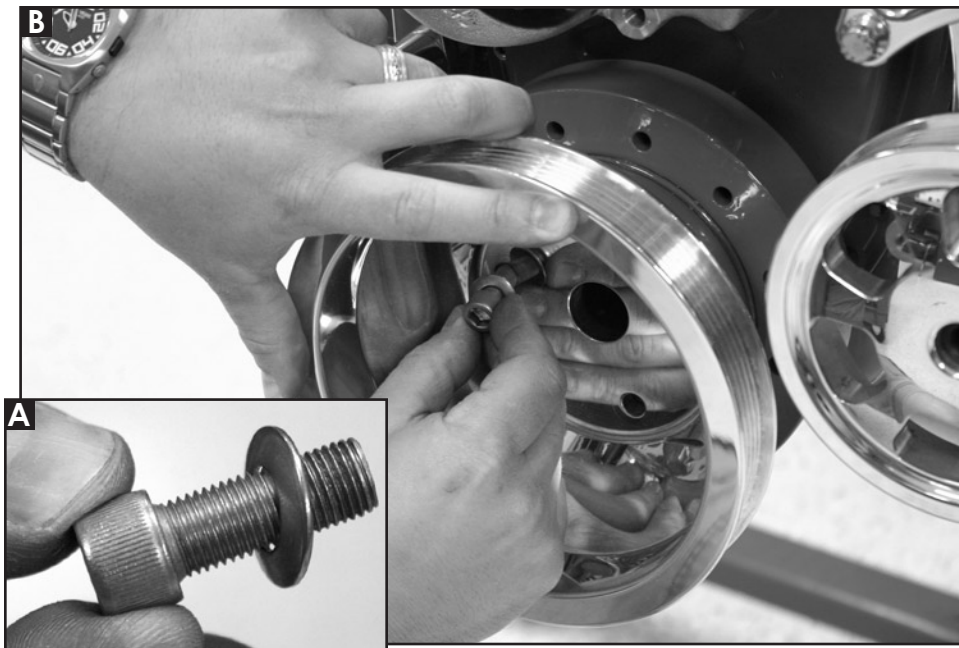

Figure 11: Install Crankshaft Pulley

A] Apply Loc-Tite to the threads of the three 3/8-24 x 1" socket head cap screws and place a Belleville washer with the cup facing away from the socket head on each fastener.

B] Place the crank pulley on damper and align holes. Thread the three 3/8" cap screws with washers through pulley and into damper, tighten firmly (50 ft/lbs.).



Figure 12: Install Water Pump Pulley

Apply Loc-Tite to the threads of the four 5/16-24 x 1/2" socket head cap screws.

Place the water pump pulley to the water pump and thread the cap screws through pulley and into water pump pulley flange, tighten firmly (28 ft/lbs.)



Figure 13: Install Compressor Clutch Cover

Apply Loctite Blue 242 to the following:
(3) 1/4-20 x 3/4" socket head cap screws

Place cover on clutch and thread the socket head cap screws through the cover and into the clutch, torque to 40-45 **inch/lbs.**

Caution: Over tightening these fasteners will cause damage to the compressor clutch. **Do Not Over Tighten.**

www.billet specialties.com

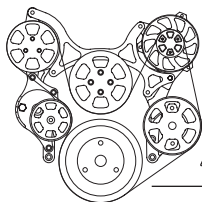

Billet Specialties

TRU Trac



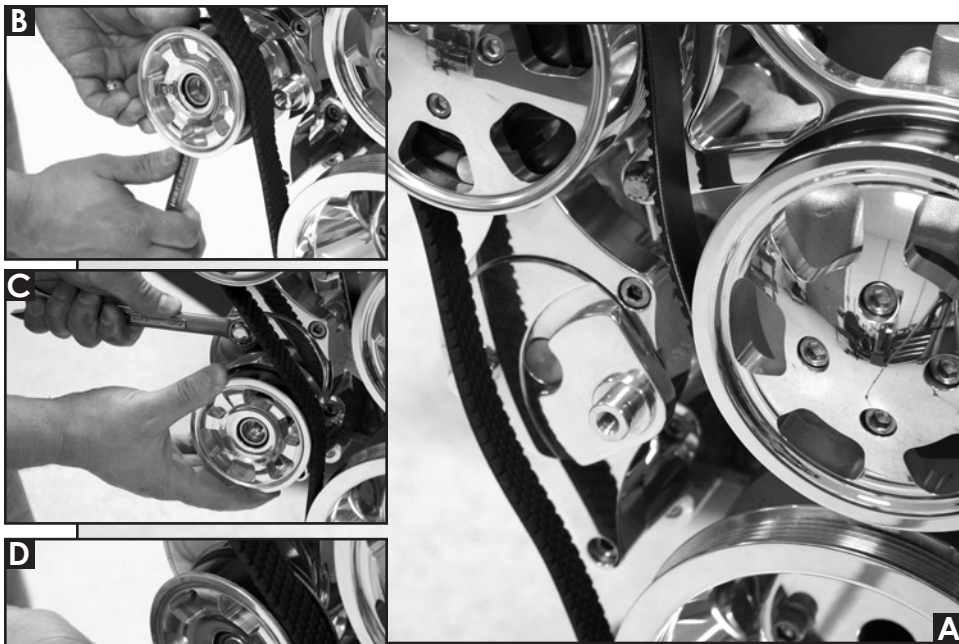

Figure 14: Install Serpentine Belt & Tensioner Pulley

A) Route belt as shown minus tensioner pulley.

B) Place a 5/8" box end wrench on tensioner, align belt onto groove of tensioner pulley.

C) Pull up on wrench until tensioner pulley hole lines up with boss on tensioner, slide pulley onto boss and slowly lower wrench to apply tension to serpentine belt.

D) Apply anti-seize to the threads of the 3/8-16 x 1/2" ARP 12pt. cap screw and thread it through the aluminum washer (packaged with tensioner pulley) into tensioner boss and tighten firmly (46 ft/lbs.).

WITH POWER STEERING

WITHOUT POWER STEERING

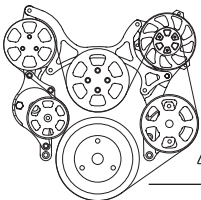
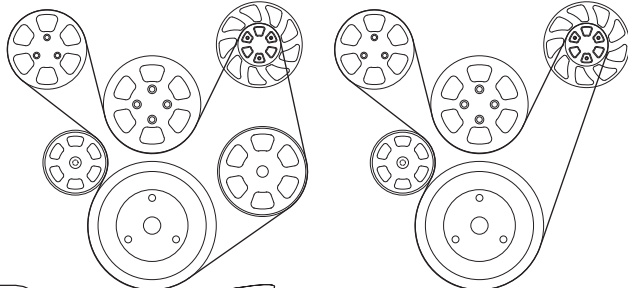

Billet Specialties

TRU Trac



Figure 15: Install Compressor Manifold

If you are going to be installing your air conditioning hoses and charging the system at this time, remove the cover plate on top of the compressor body.

A,B] Apply anti-seize to the remaining two 8mm-1.25 x 25mm socket head cap screws. Install compressor manifold onto compressor and thread the two 8mm socket head cap screws through the manifold and into the compressor, tighten firmly (25 ft/lbs.)

Install hoses, connect clutch wire and charge system.

Important

If you are NOT installing hoses and charging the system at this time, place the compressor manifold and hardware in a safe place and leave cover plate on compressor. *Do not connect the clutch wire or apply power to clutch wire without the hoses connected and the system charged – Serious damage will occur to compressor.*

Compressor Oil

Although the compressor is supplied with oil, the level may not be correct for the entire system. Consult the instruction manual of the air conditioning unit for proper levels and system charging procedure.

Apply anti-seize to the remaining two 8mm-1.25 X 25mm socket head cap screws.

www.billet specialties.com



Billet Specialties, Inc.
500 Shawmut Ave.
La Grange, IL 60526
Tech Line 708/588-0505
Fax 708/588-7181
billetspecialties.com