



Edelbrock Supercharger

2016-23 CHEVY CAMARO LT1 6.2L

Part #15595, 155950

Edelbrock®

SUPERCHARGERS



WARNING!

The supercharger bypass valve is factory installed and adjusted intended to be vacuum operated only. DO NOT move the solenoid actuator lever by hand or adjust the stop point. Moving the lever manually will damage the solenoid and the system will not function properly. Damage to the bypass assembly from manual movement will not be covered under manufacture warranty.



E-MAIL EDELBROCK YOUR STOCK VEHICLE CALIBRATION AND VEHICLE INFORMATION

PLEASE COMPLETE THIS PROCEDURE PRIOR to starting the installation of your supercharger system. This will allow our calibration team to complete your calibration file while the installation of your supercharger system is being completed. Manufacturers regularly update the factory calibration, as a result, there is the possibility for delays due to not having access to your current calibration file. This can normally be resolved in 1 business day.

FAILURE TO PROVIDE ALL OF THE INFORMATION BELOW WILL DELAY THE COMPLETION OF THE CALIBRATION FILE FOR YOUR VEHICLE. TO LIMIT VEHICLE DOWN TIME, PLEASE SEND US THE REQUESTED INFORMATION BEFORE STARTING THE SUPERCHARGER INSTALL.

Please e-mail the requested information below to calibration@edelbrock.com with the E-mail Subject as “**Calibration Update**”. We will complete your calibration and e-mail it back to you as soon as possible. MOST calibration updates will be sent back the same business day. In rare cases, it could take up to 1-2 business days to complete. Please contact our **Tech Hot Line at (800)416-8628** if you have any questions or if you need assistance with this procedure.

- Begin by downloading the SCT device updater software to your computer; it can be downloaded from: <http://www.sctflash.com/software/SCTDeviceUpdater.exe>.
- Put the vehicle into ACC mode but do not start the engine.
- Connect the supplied PCM cable from the programmer to the OBD-II connector.
- Select PROGRAM VEHICLE, use the arrow keys to highlight UPLOAD STOCK and press SELECT. Follow the prompts on the screen. **NOTE: Use E92 for Engine Type and T43 or T43a (2014 Automatic Only) for Transmission Type.**
- If the upload fails, you will be asked to AUTO DETECT. Press SELECT and follow the prompts on the screen. If the auto detect fails, please contact Edelbrock Tech Support @ 800-416-8628.
- Once the stock calibration has loaded to the handheld programmer, disconnect the programmer from the OBD-II connector and connect it to your PC using the supplied USB cable.
- Open the SCT software and select the button on the lower left hand side that reads GET STOCK FILE FROM DEVICE. Follow the instructions on the screen. **NOTE: The stock calibration file will automatically be labeled using your VIN number followed by “.sul” (XXXXXXXXXXXX.sul)**
- Once the download is complete, you can E-mail your stock vehicle calibration along with the vehicle information below to calibration@edelbrock.com or call 800-416-8628 and our Tech Support staff will assist you with E-mailing the file. **NOTE: The subject line of your E-mail should read “Calibration Update”.**
- Once we have the stock calibration file, along with the requested information below, we can update the calibration to work with your application. We will E-mail you the custom calibration which may be used until the release version of the calibration is available.

INFORMATION NEEDED:

E-Mail Address:
Vehicle Year:
Vehicle Make:
Vehicle Model (Specify if Z06, Z51, etc.):
Engine Size:
Transmission:

Fuel Octane (91 or 93 ONLY):
Supercharger System Part Number:
Supercharger Serial Number:
Programmer Serial Number:
Location Vehicle Is Registered:

2014-2023 GM SCT BDx Instructions



1. Begin by downloading the SCT device updater software:
<http://cdn.derivesystems.com/software/SCTDeviceUpdater.exe>
2. With the device updater open connect the BDx to your PC with the supplied USB cable and verify it is up to date by selecting **AUTOMATICALLY CHECK FOR UPDATES**.
3. Once any updates have been completed, using the supplied OBD cable, connect the BDx to the vehicles OBD port.
4. Put the vehicles ignition into ACC mode but do not start the engine.
5. Select **PROGRAM VEHICLE**. You will then be prompted to confirm the VIN#. If the vehicles VIN# is displayed on the programmer screen, highlight and select **CONFIRM**. If the correct VIN# is **NOT** displayed select **CONNECT** to identify the vehicle.



6. After verifying the VIN# you will be prompted to connect the BDx to WIFI.



7. Select the available WIFI network and follow the prompts to complete the connection. With a successful WIFI connection established, the programmer will begin updating files and firmware for the BDx.



8. Once all WIFI updates are completed, a **CLOUD SYNC** screen will appear. Select **SKIP**, as we will be emailing the calibration file to you.



9. After selecting **SKIP** for the **CLOUD SYNC**, the **STREET USE NOTICE** will appear. Select **UPLOAD STOCK** and follow the prompts to complete the upload of the stock (.sul) file.

- Once the stock calibration has loaded to the handheld programmer, disconnect the programmer from the OBD-II connector and connect it to your PC using the supplied USB cable.
- Open the **SCT Software** and select the button on the lower left hand side that reads **GET STOCK FILE FROM DEVICE**. Follow the instructions on the screen. **NOTE: The stock calibration file will automatically be labeled using your VIN number followed by ".sul" (XXXXXXXXXXXXX.sul)**
- Once the download is complete, you can E-mail your stock vehicle calibration along with the vehicle information below to calibration@edelbrock.com or call 800-416-8628 and our tech support staff will assist you with E-mailing the file. **NOTE: The subject line of your E-mail should read, "Calibration Update"**.
- Once we have the stock calibration file, along with the requested information below, we can update the calibration to work with your application. We will E-mail you the custom calibration which may be used until the release version of the calibration is available.

INFORMATION NEEDED:

E-Mail Address:

Vehicle Year:

Vehicle Make:

Vehicle Model (Specify if Z06, Z51, etc.):

Engine Size:

Transmission:

Fuel Octane (91 or 93 ONLY):

Supercharger System Part Number:

Supercharger Serial Number:

Programmer Serial Number:

Location Vehicle Is Registered:



INTRODUCTION

Thank you for purchasing the Edelbrock Supercharger for the Chevy Camaro Gen V LT1. This Edelbrock Supercharger System utilizes Eaton's Gen VI R2650 TVS Supercharger rotors housed inside a redesigned supercharger manifold. The manifold is Edelbrock's most advanced supercharger design to date and fits under the factory hood with no modifications. The supercharger retains an inverted orientation which expels air upward through the intercooler core. Air pressure then builds in the plenum before being forced down through the intercooler resulting in incredibly low IATs to support more power.

The supercharger is 50-State emissions legal (pending), and includes a 3-year 36,000 mile warranty when applicable

Installation time: Approximately 11 hours.

TOOLS AND SUPPLIES REQUIRED

- Jack and Jack Stands OR Service Lift
- Claw-Type Harmonic Balancer Puller
- Harmonic Balancer Installation Tool
- Ratchet and Socket Set including but not limited to: 7mm, 8mm, 10mm (standard, deep and swivel), 11mm, 12mm, 13mm, 15mm, 18mm, 21mm, 24mm
- Wrench Set including but not limited to: 8mm, 10mm, 15mm, 11/16"
- Breaker Bar: 1/2"
- Compressed Air
- Power Drill
- Drill Bit: 1.75" Hole Saw
- Torx Drives: T15, T30
- Panel Puller
- Razor Blade
- Flat Blade & Phillips Screwdrivers
- Coolant Drain Bucket
- 50/50 Coolant Mixture
- Side Cutters
- 3/8" Fuel Line Removal Tools
- Torque Wrench
- Angle Meter
- GM Flywheel Holding Tool
- Pliers OR Hose Clamp Removal Tool
- Blue, Green and Red Thread Retaining Compound
- O-ring Lube
- Masking Tape
- Shop Rags
- Non-Black Sharpie or equivalent
- Wire Ties

IMPORTANT WARNINGS

Before beginning the installation, use the enclosed checklist to verify that all components are present in the box. Then inspect each component for damage that may have occurred in transit. If any parts are missing or damaged, contact Edelbrock Technical Support (800-416-8628), not your parts distributor.



WARNING: Installation of this supercharger will result in a significant change to the performance characteristics of your vehicle. It is highly recommended that you take some time to familiarize yourself with the added power and how it's delivered. This must be done in a controlled environment. Take extra care on wet and slippery roads as the rear tires will be more likely to lose traction with the added power. It is never recommended to turn off your vehicles traction control system.

Proper installation is the responsibility of the installer. Improper installation will void all manufacture's standard warranties and may result in poor performance and engine or vehicle damage.

Inspect all components for damage that may have occurred in transit before beginning installation. If any parts are missing or damaged, contact Edelbrock Technical Support, not your parts distributor.

Due to the complexity of the Edelbrock Supercharging system, it is recommended that this system only be installed by a qualified professional with access to a service lift, pneumatic tools, and a strong familiarity with automotive service procedures. To qualify for the drivetrain warranty, it is necessary to have this system installed by a Certified ASE Technician at a licensed business, GM Dealership, or an Authorized Edelbrock Installer. Failure to do so will void and/or disqualify any and all optional supplemental warranties offered with this system. Please contact the Edelbrock Technical Support department if you have any questions regarding this system and/or how your installer of choice will affect any warranty coverage for which your vehicle may qualify.

Any previously installed aftermarket tuning equipment must be removed and the vehicle returned to an as-stock condition before installing the supercharger.

Any equipment that directly modifies the fuel mixture or ignition timing of the engine can cause severe engine damage if used in conjunction with the Edelbrock Supercharger System. This includes, but is not limited to: OBDII programmers, MAF sensors, adapters and any other device that modifies signals to and/or from the ECU. Aftermarket bolt-on equipment such as underdrive pulleys or air intake kits will also conflict with the operation of the supercharger and must be removed prior to installation. Use of any of these products with the Supercharger could result in severe engine damage.

IMPORTANT WARNINGS CONT'D



91 octane or higher gasoline is required at all times. If your vehicle has been filled with anything less, it must be run until almost dry and refilled with 91 or higher octane gasoline twice prior to installation.

Any failures associated with not using premium 91 octane gasoline or higher, will be ineligible for warranty repairs.

It is recommended that you check the Edelbrock Tech Center Website for any updates to this installation manual. Please refer to the lower right hand corner to verify that you have the latest revision of this installation manual before beginning the installation.

Tech Center: http://www.edelbrock.com/automotive_new/misc/tech_center/install/index.php



WARNING: Installation of this supercharger and charge air cooler may require removal and replacement of front grille, front bumpers, or other pieces which may be equipped with Advanced Driver Assistance Systems (ADAS). ADAS Systems include, without limitation:

- Forward Collision Warning
- Auto braking
- Lane Departure Warning
- Lane Keeping Assist
- Blind Spot Warning
- Rear Cross Traffic
- Rearview Camera
- And various other OEM ADAS Equipment

It is the responsibility of the installer to ensure that all necessary ADAS systems that require post-repair calibrations/targeting/aiming is performed by qualified repair facilities. Edelbrock assumes no liability whatsoever with respect to any damages or losses with respect to any ADAS systems.

Edelbrock Authorized Installer Disclaimer

Authorized installers of Edelbrock products are independent companies over which Edelbrock has no right of control. Edelbrock LLC makes no claims regarding the abilities, expertise or competency of individual employees of any authorized installer. Each authorized installer is an independent company and makes its own independent judgments. Edelbrock LLC specifically disclaims any responsibility to any party including third parties for the actions, or the failure to act, of individuals, agents or a company authorized in the installation of Edelbrock LLC products.

INSTALLATION HARDWARE IDENTIFICATION GUIDE
(Parts Are Not To Scale)

BAG #1 - FEAD HARDWARE				
Item	P/N	QTY.	Description	Torque Spec
1	36-1570	2	Bolt, Hex Flange, M10 x 100mm	32 ft.-lbs
2	36-0159	2	Bolt, Hex Flange, M8 x 55mm	22 ft.-lbs
3	36-1519	3	Bolt, Hex Flange, M8 x 40mm	22 ft.-lbs



BAG #2 - INTERCOOLER HARDWARE				
Item	P/N	QTY.	Description	Torque Spec
1	36-4011	2	Bolt, Hex Flange, M8 X 25mm	N/A
2	36-1507	3	Bolt, Hex Flange, M6 X 16mm	N/A
3	36-1552	2	Bolt, Hex Flange, M6 X 10mm	N/A
4	36-1541	2	M6 Lock Nut	N/A
5	12-1590	2	Push Pin Tree	N/A
6	46-2155	8	3/4" Hose Clamp	N/A

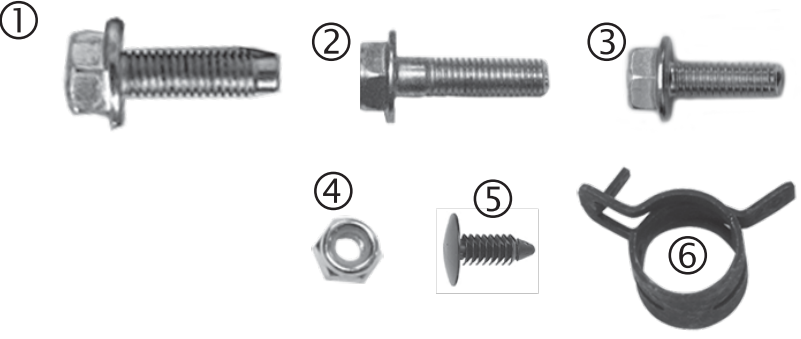

BAG #3 - MANIFOLD / RUNNER HARDWARE				
Item	P/N	QTY.	Description	Torque Spec
1	36-4053	14	Bolt, Hex Flange, M6 x 40mm	8 ft.-lbs



BAG #4 - COIL COVER HARDWARE				
Item	P/N	QTY.	Description	Torque Spec
1	36-4053	3	Bolt, Hex Flange, M6 x 40mm	N/A
2	36-1533	1	Bolt, Hex Flange, M6 x 35mm	N/A



BRACKET AND FEAD IDENTIFICATION GUIDE
(Parts Are Not To Scale)

Item	P/N	QTY.	Description
1	38-1608	1	Tensioner Bracket
2	38-1609	1	Tensioner, CTS-V
	51-4233	1	Balancer / Damper (Not Pictured)
3	51-3992	1	Idler Pulley
4	51-3994	1	Idler Pulley
5	51-3993	1	Idler Pulley
6	38-0187	1	Horn Relocation Bracket
7	38-0129	1	Water Pump Bracket
8	51-4216	1	Bolt, Damper
9	38-0200	1	Surge Tank Bracket

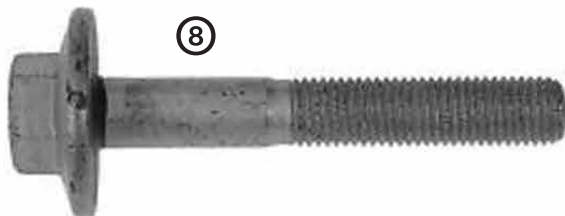
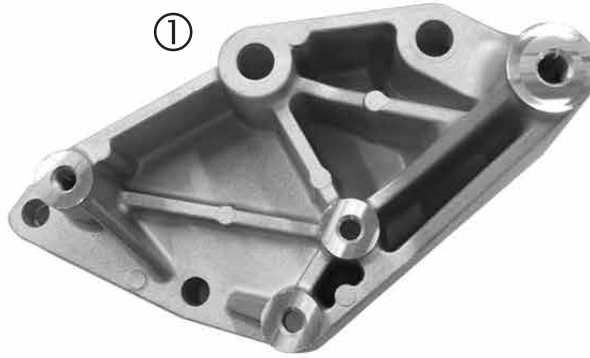



SUPERCHARGERS

Edelbrock E-Force Supercharger System
2016-23 Chevy Camaro LT1 6.2L

INSTALLATION INSTRUCTIONS

HOSE IDENTIFICATION GUIDE

(Parts Are Not To Scale)

	P/N	QTY.	Description
1	22-1657	1	Hose, Valley to Inlet
2	22-15597	1	EVAP Hose Assembly
3	22-15599	1	Air Intake Inlet PCV
4	51-4257	1	Hose, LTR to WP
5	56-1626	1	Hose, Surge Tank to S/C
6	56-1625	1	Hose, Surge Tank to WP
7	56-1627	1	Hose, S/C to LTR
	56-1000	13.5"	Hose, Brake Booster
	56-1000	54"	Hose, PCV, Driver Side
	56-0999	13"	Hose, Bypass





SUPERCHARGERS

Edelbrock E-Force Supercharger System
2016-23 Chevy Camaro LT1 6.2L

INSTALLATION INSTRUCTIONS

HOSE ROUTING DIAGRAM

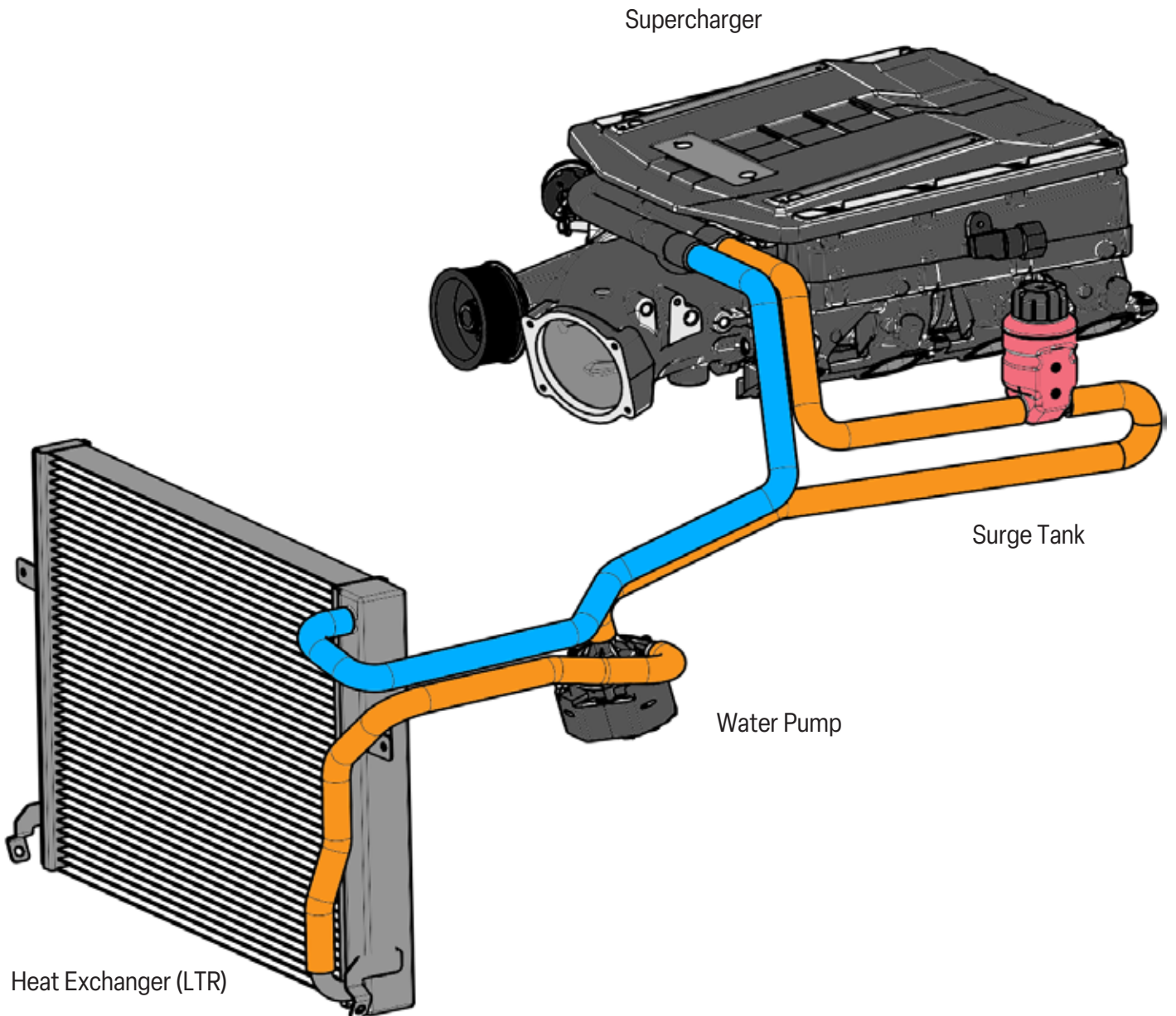

WIRE HARNESS GUIDE

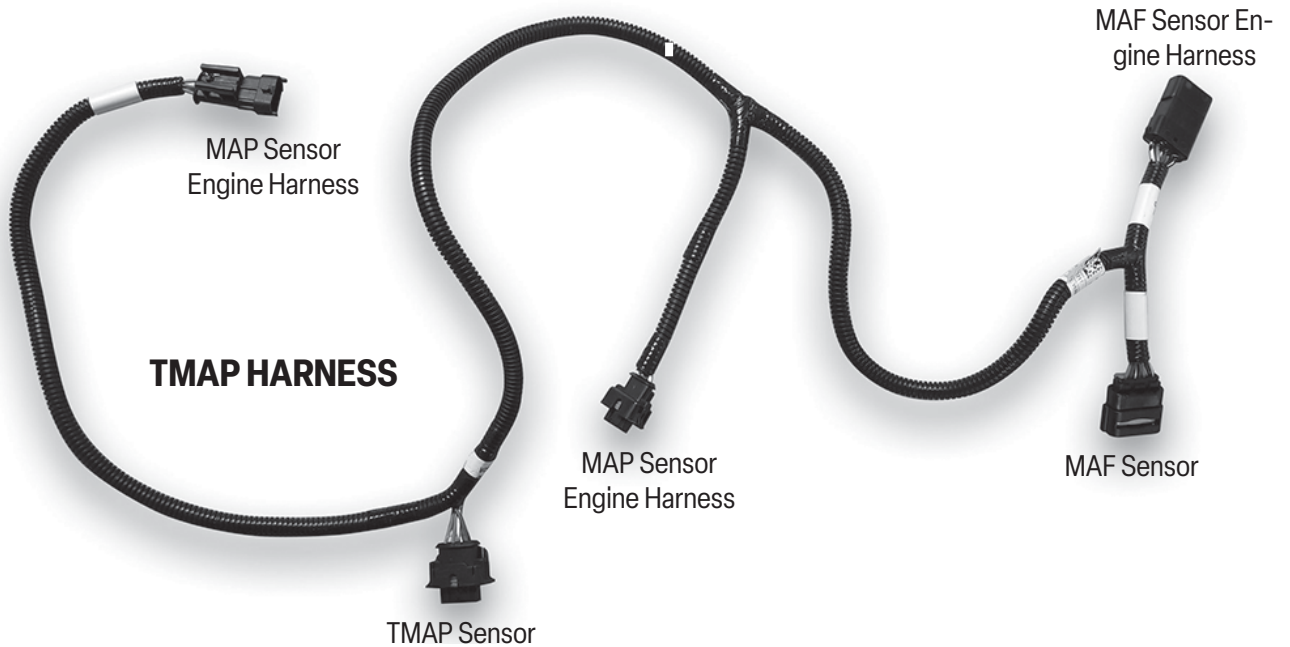
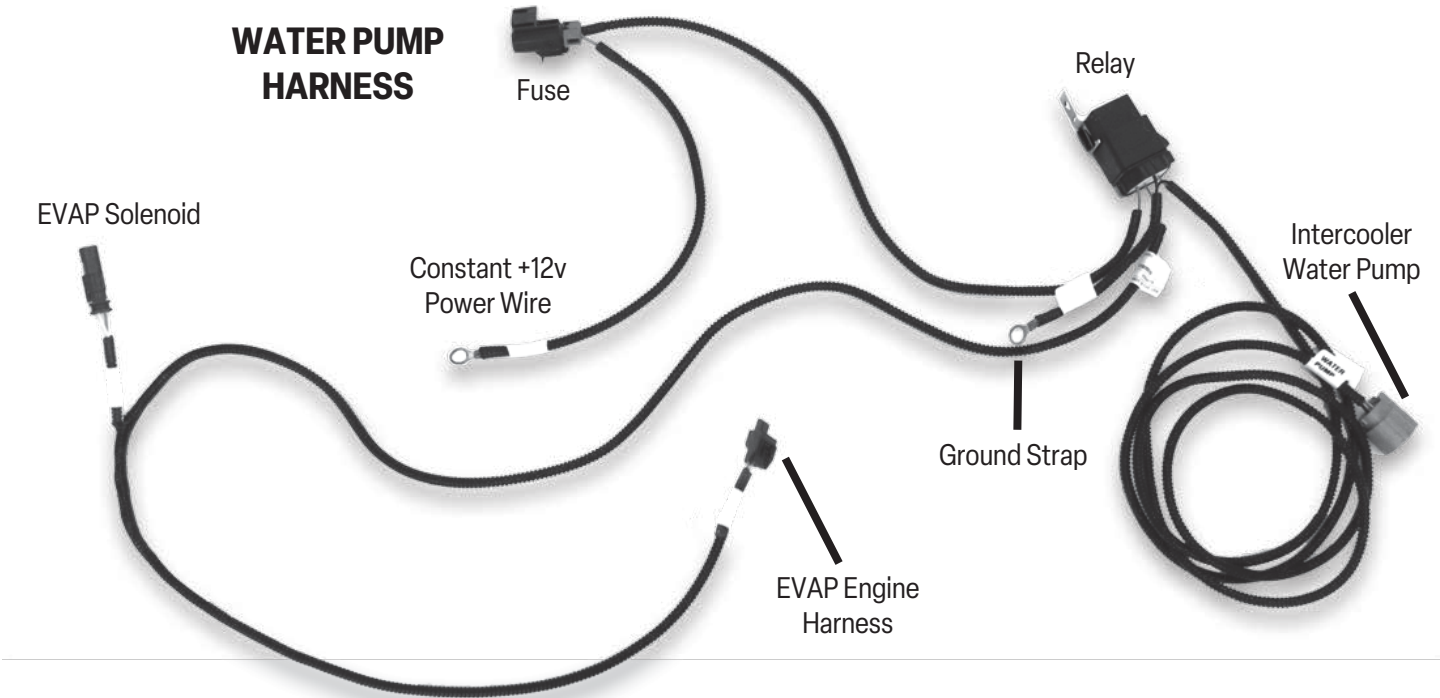

SUPERCHARGER INSTALLATION

1. Open the trunk and access the battery via the door on the passenger side trunk liner. Using a 10mm socket, disconnect the negative battery terminal.



2. Using a T-15 Torx driver, remove ten (10) screws securing the top of the fascia. Using a 10mm socket along with a T-30 Torx Driver, remove six bolts securing the radiator shroud. Remove the (1) push clip on the passenger side. *NOTE: there's two small plastic spacers that can fall out when the bolts are removed. It should be carefully removed and set aside to be re-installed later.*

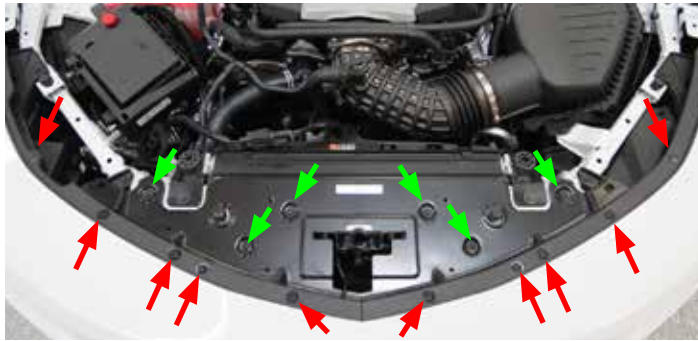

3. Using a 7mm socket, remove the bolts securing the bottom of the fascia.



NOTE: Although not required, removal of the front wheels will simplify the following procedures.

4. Use a T-15 Torx drive to remove six (6) screws securing the sides of the fascia; three (3) per side.



5. Use a 7mm socket to remove six (6) screws securing the corner of the fascia to the fender; three (3) per side.



6. Pull back the wheel liner and remove eight (8) additional screws securing the fascia to the fender; four (4) per side. *NOTE: Fourth bolt not shown, location is above top bolt.*

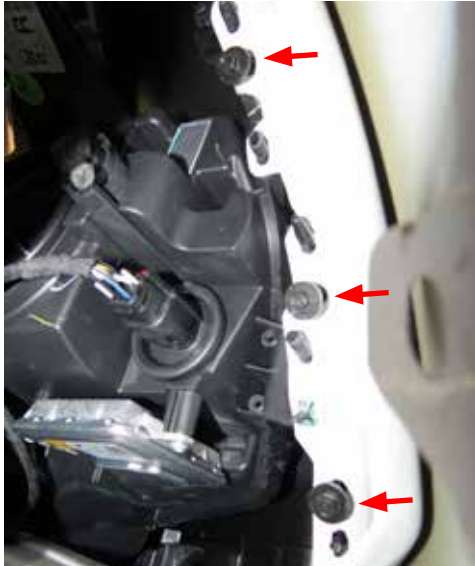

7. Disconnect the lamp and sensor harness located on the left side of the vehicle and carefully remove the fascia.

8. Using a 10mm socket, remove the 6 bolts securing the undertray. Remove the remaining plastic clip along with the tray.



9. Drain the coolant by turning the petcock on the radiator until coolant flows out. **NOTE:** If possible, place a short hose on the petcock drain to avoid unnecessary spills.

10. Remove the strut tower brace by removing the four bolts. Ensure to replace the shorter bolt back into the strut tower.



11. Carefully remove the factory manifold side covers.



12. Remove the fresh air PCV hose attached to the inlet elbow.



13. Using a hose clamp tool, remove the noise generator hose from the inlet elbow. Loosen the warm clamps securing the inlet elbow and remove the elbow.



14. Remove the driver side PCV hose.



15. Using a 10mm socket, remove the nut securing the noise generator to the firewall.



16. Remove the noise generator assembly by twisting the hose clockwise to unlock it from the firewall.



17. Disconnect the electronic throttle body connector from the throttle body.



18. Unclip the fuel line from the top of the manifold.



19. Using a deep 10mm socket, remove four (4) bolts securing the manifold cover. Unplug MAP sensor, and cut ties holding the harness to the intake. Do NOT damage the harness.



20. Remove the valley to manifold PCV hose.



21. Remove the EVAP line from the hardline located on the firewall and from the EVAP solenoid.



22. Disconnect the brake booster line assembly from the junction on the driver side strut tower.



23. Unplug the MAP connector from the MAP sensor. Remove the MAP sensor from the manifold using a 10mm socket. This sensor will be reused later in the installation.



24. Disconnect EVAP connection. Using a 10mm socket, remove ten (10) bolts securing the intake manifold to the cylinder heads. Carefully remove the intake manifold assembly.



25. Clean the intake port surfaces with a shop rag. Cover the ports with protective tape to keep out debris. Remove the black foam insulator from the valley and set aside.



26. Install the supplied grommet onto the firewall where the noise generator was removed.

27. Remove the retaining clip on the fuel feed line. Using a 3/8" fuel line tool, disconnect the fuel line from the fuel line extension and from the factory hardline. **CAUTION: Place a shop rag around the fuel line to prevent fuel from spraying.**



28. Remove oil cap. Using a Torx T30, remove the driver and passenger side coil covers. Replace oil cap to prevent debris from falling into the engine.

29. Remove the serpentine belt by using a 15mm socket on the tensioner pulley bolt. Rotate the bolt on the tensioner clockwise until the belt is free.

30. Using a stretchy belt removal/installer tool, remove the belt from the A/C compressor and the damper.

NOTE: Steps 31-37 will highlight the procedure to remove the electric cooling fan as required to install the supplied damper.

31. Use a 7mm socket to remove the three (3) bolts securing the bottom of the fan shroud.



32. Disconnect the electric fan connector. Use a panel puller to detach the harness tree-clip from the fan shroud.



33. Using a hose clamp removal tool, remove the upper radiator hose and the overflow hose from the radiator.



34. Using a hose clamp removal tool, detach the lower radiator hoses. 2017 model year Camaros only have drivers side lower hose. *NOTE: The clamps may not come off because of adhesive. Simply compress the clamp and pull the hose simultaneously.*



35. Remove the retaining clip securing the transmission cooler line to the radiator and remove the transmission cooler line. *NOTE: Be extremely cautious not to drop or lose this clip. Keep the clip in a safe place to be re-installed later.*



36. Using a panel puller, remove the coolant lines from the fan shroud.



37. Remove two (2) bolts securing the electric fan to the radiator using a 10mm socket. Carefully remove the electric fan assembly.

NOTE: Steps 38-46 will highlight the steps required to remove the starter to install the GM flywheel holding tool.

38. Using a hose clamp tool, disconnect the overflow hose and the feed hose from the coolant reservoir.



39. Using a deep 10mm socket, remove three (3) nuts securing the coolant reservoir tank. Remove reservoir and set aside.



40. Using a panel puller, remove the engine harness from the support bracket located on the passenger side valve cover.



41. Using a 10mm socket, remove the engine harness support bracket. This bracket will not be reused.



42. Disconnect the passenger side spark plug wires from the coil packs.

43. Remove the four nuts securing the passenger exhaust manifold to the lower exhaust pipe.

44. Remove the bolt securing the oil dip stick using a 10mm socket.



45. Remove five (5) bolts securing the passenger side exhaust manifold to the cylinder head. Carefully remove the exhaust manifold along with the dipstick. Discard the exhaust manifold gasket.

46. Remove the starter and heat shield to install a GM flywheel holding tool.



47. Using a 24mm socket and a breaker bar, remove the factory harmonic balancer bolt. Do not discard the bolt at this time as it will be temporarily used during the installation procedure.

48. Remove the factory harmonic balancer using a Claw-Type Damper Puller.



49. Apply white grease to the snout of the crank and to the inside of the balancer hub. Apply clean engine oil to the outside of the balancer hub.

50. Line up the key on the crank with the key way on the harmonic balancer. Install the supplied harmonic balancer using an appropriate harmonic balancer installation tool.

NOTE: The balancer should be positioned onto the end of the crankshaft as straight as possible prior to tool installation.



51. Using a 24mm socket and a torque wrench, install the used factory balancer bolt and torque it to 240 ft-lbs. Then remove the factory balancer bolt and discard.

NOTE: The nose of the crankshaft should be recessed 8mm (.31" in) into the balancer bore. Measure for a correctly installed balancer. If the balancer is not installed to the proper dimensions, repeat the installation procedure until the proper dimensions are achieved.

52. Using a 24mm socket and a torque wrench, install the new supplied balancer bolt and torque it to 110 ft-lbs. Loosen the bolt 360° and re-torque the bolt to 59 ft-lbs. + an additional 125° of rotation.

53. Remove the flywheel holding tool and reinstall the starter, heat shield and plastic transmission cover.

54. Reinstall the exhaust manifold and dipstick using the supplied exhaust manifold gasket.

55. Reinstall the exhaust, spark plug wires, and engine harness bracket. **NOTE:** If using Edelbrock coil covers, the harness bracket will not be used.

56. Using a stretchy belt removal/installation tool, install the factory stretchy belt onto the new damper and the A/C compressor. **NOTE:** Be careful not to damage the belt. Inspect the belt for any damage after the installation.



57. Install the factory accessory drive belt using the routing diagram below.

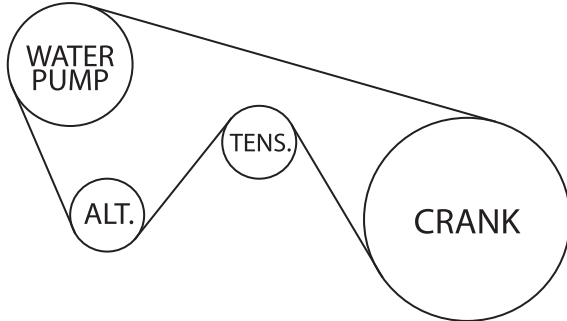

58. Using a 3/4" hose clamp from hardware Bag #2, secure the WP to Surge Tank hose to the water pump noting the orientation of the hose.



59. Install the supplied water pump isolator onto the water pump noting the orientation.



60. Remove the two (2) chassis bolts adjacent to the radiator assembly. OPTIONAL: Removing the air filter housing will give better access to these bolts.

TIP: A secondary wrench may be required to hold the nut located inside the chassis frame.

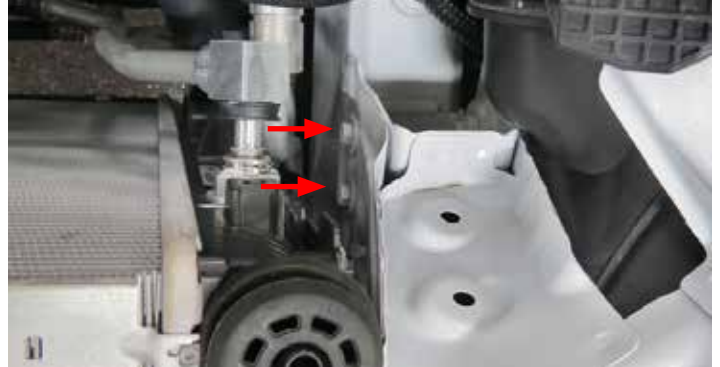

61. Install the water pump assembly onto the water pump bracket. Using the washers from hardware Bag #2 and the factory chassis bolts, mount the water pump bracket to the frame in the location where the chassis bolts were removed. TIP: A secondary wrench may be required to hold the nut located inside the chassis frame.

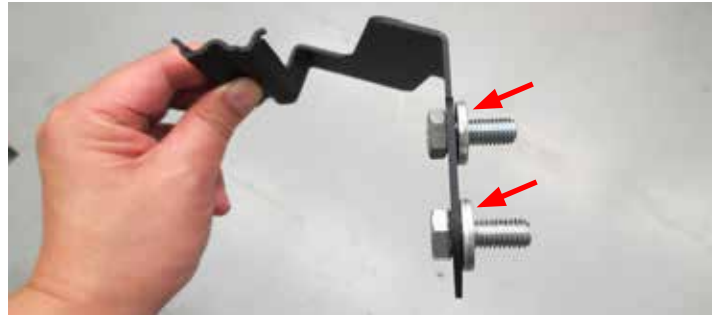

62. Using a 13mm socket, remove the ground strap from the engine block. Location is directly above the A/C compressor.



63. Disconnect the engine harness located on the front of the driver side cylinder head. Using a 13mm socket remove the bolt securing the harness to the head.



64. Install the supplied tensioner bracket to the provisions on the cylinder head and engine block using two (2) M10 x 100mm bolts and two (2) M8 x 55mm bolts supplied in hardware Bag #1. Torque M10 bolts to 32 ft-lbs and M8 bolts 22 ft-lbs.



65. Position the ground strap behind the engine harness bracket and secure the engine harness to the cylinder head. Reconnect the engine harness.



66. Install the supplied tensioner onto the FEAD bracket using three (3) M8 x 40mm bolts from hardware bag #1. Torque bolts to 22 ft-lbs.



67. Install the larger grooved idler pulley to the FEAD bracket. Torque bolt to 22 ft-lbs.



68. Install the smooth idler pulley to the upper water pump provision and the smaller grooved idler to the lower water pump provision. Torque both bolts to 22 ft-lbs.



INSTALLATION INSTRUCTIONS

69. Position the EVAP hard line in front of the fuel hard line. Split the supplied foam tube down the middle with a razor and secure it to the EVAP hard line with wire ties.



70. Connect the supplied fuel feed line to the hard line on the firewall and route it over towards the fuel adapter line. Secure the fuel line to the brake line with wire ties.

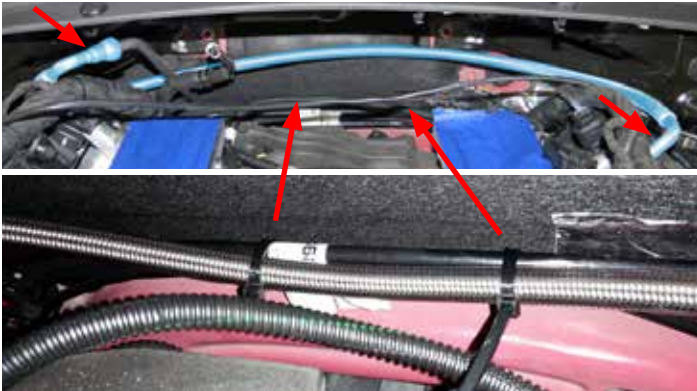

71. Remove the factory O-ring gaskets from the intake manifold.



72. Clean and inspect the O-ring gaskets. Replace torn or damage O-rings as needed. Using a razor blade remove the tips off all eight (8) factory O-ring gaskets.

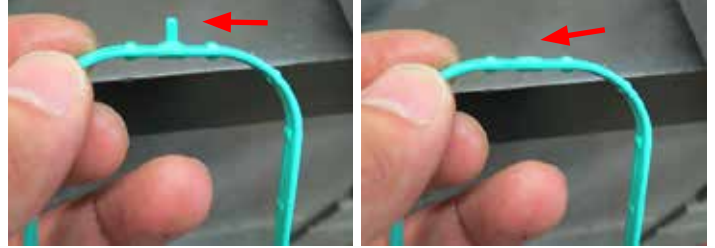

73. Install eight (8) modified O-ring gaskets onto the runners.



74. Unplug all of the coil packs and pull the harnesses outward on both sides.

75. Remove the protective tape from the cylinder head ports. With help from an assistant, carefully lower the supercharger onto the engine.

76. Apply Blue thread locker to the eight (8) M6 x 40mm hex flange bolts from Bag #3. Using a 10mm socket, secure the manifold to the engine using the torque sequence below. Torque bolts to 4 ft-lb. (48 in-lb.) and then to 8 ft-lb. (96 in-lbs.).

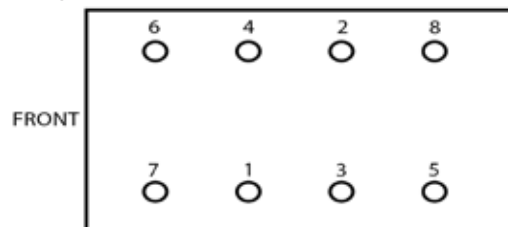

77. NOTE: Early supercharger kits included a MAP sensor adapter/hose assembly. If your kit has this item, skip to the next step. Using O-ring lube on the MAP O-ring, install the factory sensor into the MAP port as pictured below. Connect the MAP harness connector.



78. If equipped with the MAP adapter/hose assembly, install the long end of the nose, the short fitting end to the brake booster extender, and insert the factory MAP sensor and adapter into the short, straight hose end. Secure the sensor adapter with the supplied hose clamp.



79. Using a 10mm socket, remove the EVAP solenoid from the stock manifold. Inspect the O-ring gasket and replace if needed.



80. Apply O-ring lube to the O-ring on the EVAP solenoid and install EVAP port using the factory EVAP solenoid bolt.



81. Connect the Valley to Inlet hose to the fitting located on the valley cover, to the manifold inlet.



82. Using a breaker bar, rotate the tensioner counterclockwise and install the supercharger belt using the routing diagram below.

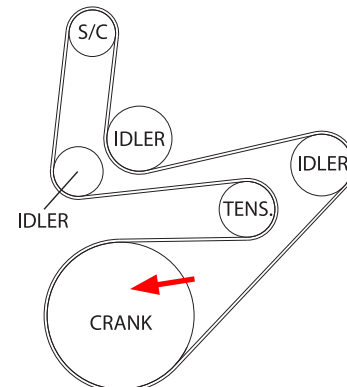

83. Using a 10mm socket, remove four (4) bolts securing the throttle body to the factory manifold.

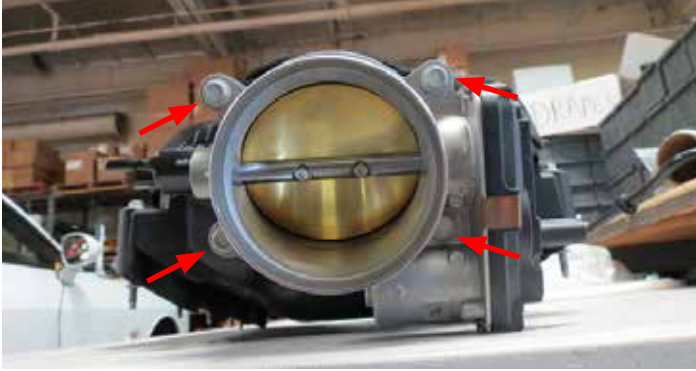

84. Using the supplied gasket and four (4) M6 x 40mm hex flange bolts from Bag #3, secure the throttle body to the supercharger inlet. Reconnect the electronic throttle body connector to the throttle body.



85. Using a 13mm socket, remove the hood latch assembly and the crash beam support braces. Set the latch to the side but DO NOT disconnect the cable.

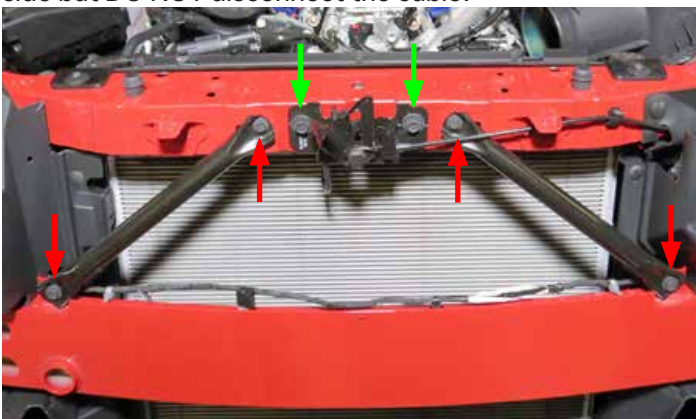

86. Disconnect and remove the horn assembly from the crash beam using a 10mm socket. Using a panel puller, remove the push pins securing the wire harness to the crash beam as well as the radiator shrouds.



87. Using a 10mm wrench and a 13mm socket, remove ten (10) bolts, five (5) per side, securing the crash beam to the chassis. Remove push pin located underneath the crash guard on each side. Remove the crash guard.

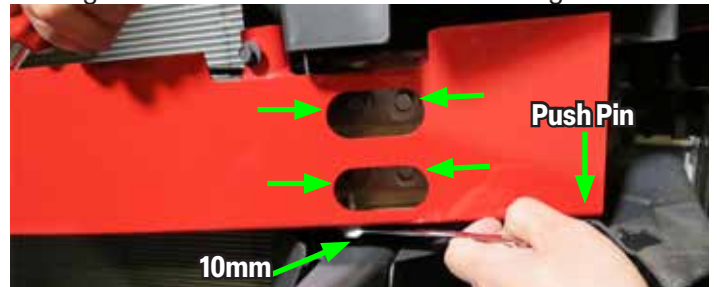

88. Using a panel puller, remove two (2) push pins securing the driver side radiator shroud to the radiator and one securing the rubber shroud. Remove both shrouds. The inner rubber shroud will not be reused.



89. Using a 1.75" hole saw, drill a hole into the center of the upper portion of the shroud. Using a cutting tool, remove some material from the center of the shroud opening as shown.



90. Reposition the shroud, and secure using the factory upper and vertical push pins.

91. Using a panel puller, remove the lower push pin from the passenger side radiator shroud.



92. Using a panel puller, remove both inner push pins securing the right and left air ducts.



93. Cut the supplied foam tape in half and line the rear side tanks of the supplied LTR as shown. TIP: Inlet bars will point towards the front of the vehicle.



94. Position the LTR in front of the radiator assembly with the inlet bars positioned on the driver side of the vehicle. Using the supplied push pins from hardware Bag# 2, secure the LTR to the radiator shrouds.



95. Secure the lower portion of the LTR to the air ducts using two (2) M6 x 16mm bolts and two (2) M6 locknuts from hardware Bag #2.



96. Remove the bolt securing the brace to the strut tower. Secure the surge tank to the surge tank bracket with two (2) M6 x 10mm bolts. Using factory bolt and supplied M8 x 25mm bolt, loosely secure the surge tank bracket to the brace. This will be removed again later in the install for the coil cover install.



99. Route the LTR to Manifold hose through the hole in the radiator shroud and back towards the manifold. Using a 3/4" hose clamp from Bag #2, secure the hose to the upper barb of the LTR.



97. Using a 3/4" hose clamp from Bag #2, secure the LTR to Water Pump hose to the bottom LTR barb. Route the hose through the center opening of the radiator shroud.



100. Using a 3/4" hose clamp from Bag #2, secure the hose from the LTR to the front water crossover barb.



98. Using a 3/4" hose clamp from Bag #2, secure the LTR to Water Pump hose to the outlet barb of the water pump.



101. Using two (2) 3/4" hose clamps from hardware Bag #2, secure the Surge Tank to Manifold hose to the surge tank and rear water cross over barb.



102. Using a 3/4" hose clamp from hardware bag #2, secure the Water Pump to Surge Tank hose to the surge tank.



103. Reinstall the crash beam, support beams and the hood latch assembly. **NOTE:** Be mindful of the alignment of the crash guard and especially the hood latch. Use the witness marks on the latch to reinstall back into the original location.

104. Using a M6 x 16mm bolt from hardware Bag #2, secure the horn assembly to the supplied horn relocater bracket.



105. Install the horn assembly in the factory location using the factory bolt. Reconnect the horn connectors.



106. Reinstall the coolant reservoir tank, the electric fan assembly, and the radiator hoses. Replace the lower radiator tray.

107. Reinstall the upper radiator shroud. Reinstall the front fascia reversing the disassembly procedure.

108. Using a razor, remove the longer hose from the check valve on the brake booster to manifold hose. Install the supplied 3/8" brake booster hose onto the check valve.



109. Connect the quick-connector on the brake booster hose assembly to the junction on the driver side strut tower. Connect the other end of the hose onto the barb on the supercharger inlet.



110. Connect the supplied EVAP hose to the hardline on the firewall at the rear passenger side of the manifold. Route the hose along the driver side of the manifold, beneath the coil wires, and connect it to the EVAP solenoid.



111. Remove the fittings from the factory driver side PCV hose and install into the provided 3/8" hose. Route the hose from the oil separator, around the front coil for cover clearance. Then route the hose around the rear of the manifold toward the driver side PCV junction.



112. Connect the TMAP harness to the TMAP sensor located on the driver side of the manifold.



113. Uninstall the surge tank bracket bolts from the strut tower so it can be moved away from the coils. Install the driver and passenger side coil covers over the hoses using three (3) M6 x 40mm bolts and one (1) M6 x 35mm bolt from hardware bag 4. Oil fill cap will need to be removed before placing the driver side cover. Replace surge tank bolts back into the strut tower and hand tighten.

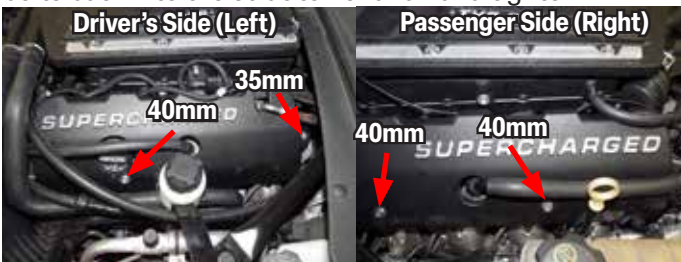

114. Verify no hoses were pinched during installation of the coil covers. Re-position as needed.

115. Reinstall passenger side factory PCV hose.



116. Connect driver side pcv hose through the hole in the coil cover.



117. Reinstall the air filter box. Insert the provided green filter and attach the air filter lid.

118. Connect the female end MAP connector on the provided harness to the factory MAP connector. NOTE: Some factory MAP connectors will have a inner left tab which will have to be trimmed.



119. Connect the MAF connectors from the TMAP harness to the MAF sensor and the factory MAF connector.



120. Using the supplied worm clamps, secure the inlet elbow to the throttle body and the air intake box.



121. Using a razor blade or equivalent, remove the 90° fitting from the factory air inlet PCV hose. Connect the fitting to the supplied air inlet PCV and attach the straight quick connect to the air inlet and the 90° quick connect to the center PCV junction.



122. Connect the POWER terminal on the water pump harness to the power junction on the fuse box.



123. Remove the factory GROUND terminal nut attached to the chassis. Attach the GROUND connector on the water pump harness to the chassis ground and secure with the factory terminal nut. Remove the nuts securing the fuse box to the chassis. Gently remove the fuse box from the mounting studs and secure the relay to the mounting stud. Reinstall fuse box nuts.



124. Route the EVAP connectors on the supplied water pump harness towards the EVAP solenoid. Install the water pump harness in-between the mating connectors on the EVAP solenoid and factory harness. TIP: Note connector orientation..





SUPERCHARGERS

Edelbrock E-Force Supercharger System 2016-23 Chevy Camaro LT1 6.2L

INSTALLATION INSTRUCTIONS

125. Route the water pump connector over and down towards water pump and connect to the water pump.

126. Secure water pump harness to existing harnesses.

127. Fill the radiator reservoir tank with GM recommended 50/50 coolant blend.

128. Fill the supercharger surge tank with a 50/50 coolant and water mixture. *NOTE: Please see "How to Prime the Edelbrock Intercooler Systems" at the end of these instructions for detailed instructions.*

129. Reconnect the battery and switch ignition to the ON position, **DO NOT START**. With the ignition switch on, check for any coolant or fuel leaks. Repair all leaks before proceeding.



130. Place the EO decal on a smooth surface in the engine compartment. Be sure to thoroughly clean the surface with alcohol or window cleaner. Decal should be located in a clear, visible location.

Congratulations on the successful installation of your new Edelbrock Supercharger System. If you have any questions, please call our Technical Support hotline at 800-416-8628 and one of our technicians will be happy to assist you.

CAUTION: Check ADAS sensors as described under the "Important Warning" section in the front of this document.



How to Prime the Edelbrock Intercooler Systems.



The electric water pump used on this Edelbrock Supercharger System has a built-in micro-processor that will vary pump cycle speed when air bubbles are present in the system. If a significant amount of air is trapped in the system, the pump may cycle at a slower speed and pulsations are likely to occur resulting in poor cooling performance.

For the best result, it is highly recommended to use a Radiator Cooling System Vacuum Purge and Refill Kit to properly evacuate the air from the intercooler system before filling with a 50/50 mixture of coolant and distilled water. If one is not available, the following procedure will be adequate.

1. Using the Lisle 24680 Spill-Free Funnel, or equivalent, secure the appropriate filler neck adapter to the surge tank.
2. Attach the funnel and fill with a 50/50 mixture of coolant and distilled water until the funnel is half full.
3. Turn the ignition to the ON position and listen for the pump's electric motor to cycle. Air bubbles will begin to purge from the system as the coolant level drops. Add coolant to the funnel as necessary. *NOTE: Do NOT let the coolant level in the funnel run empty as this may introduce air into the system.*
4. To build more pressure in the intercooler system, try squeezing the intercooler hoses while the pump is cycling. Building pressure in the system will help purge the trapped air from the intercooler system.
5. Cycle the ignition OFF and wait a few seconds for the pump to come to a stop.
6. Cycle the ignition ON again and repeat until the sound of the electric pump is continuous without any pulsation. *NOTE: During water pump start-up, it is normal for a slight pulsation to occur. Once the pump has reached its maximum cycle speed, no pulsations should be present.*
7. Periodically inspect the water pump flow after a few drive cycles and re-fill the intercooler system as necessary.
8. Several drive cycles may be required to completely purge the air from the intercooler system. During a drive cycle, the intercooler system will build up pressure as the supercharger temperature increases. Any residual air trapped in the system will gradually bleed out of the surge tank as the system reaches a pressure above 5psi.

WARNING: Always avoid removing the surge tank cap when the engine is hot. The hot coolant is under pressure and may spray out causing burns.